

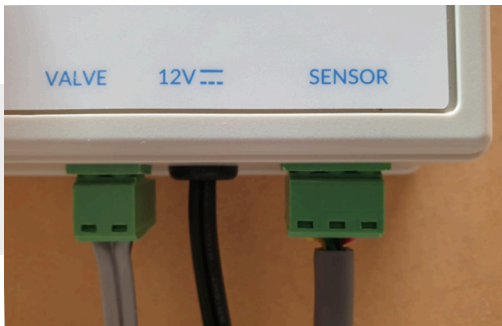

SOLENOID INSTALLATION

- The solenoid and backflow prevention valve arrows must point in the same direction. Install into water supply/fill line in direction of the flow.
- Connect solenoid cable to the solenoid and control box.

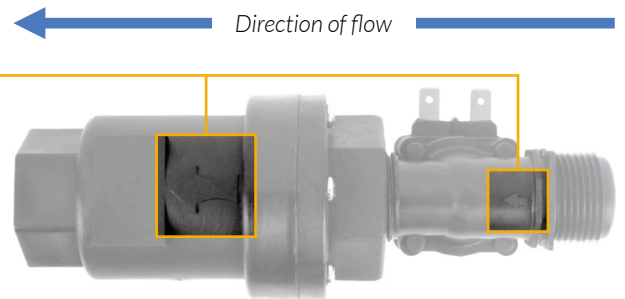

NOTE

Sensor and solenoid plugs must be inserted into the Water Witch control box with the fastening screws facing away from you.

OPTION 1 Solenoid installed into separate balance line

NOTE

The solenoid and backflow prevention valves must be installed in a separate balance line to the sensor **OR** be plumbed into the filtration return line.

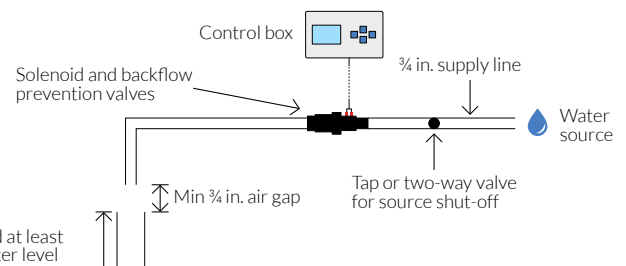
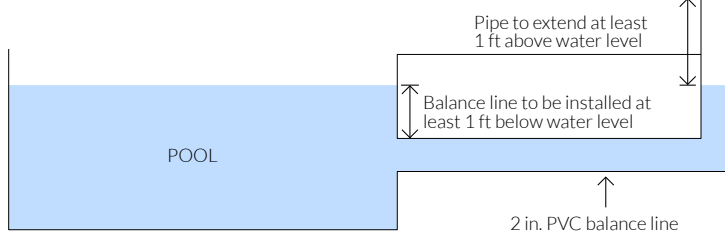

NOTE

1/4 in. air gap may not be required where a backflow prevention valve is installed. Check with your local water authority for specific requirements.

OPTION 2 Solenoid installed into filtration return line

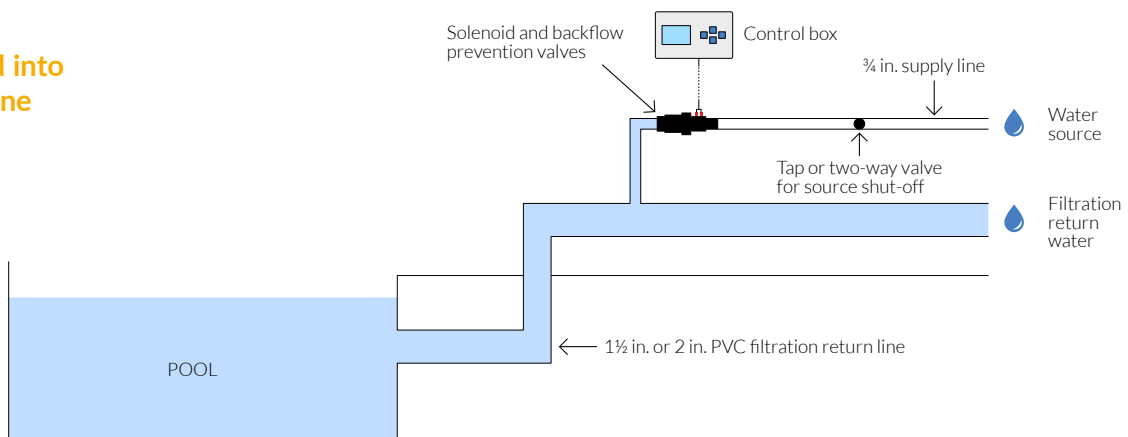

SENSOR INSTALLED INTO BALANCE LINE

- Connect the sensor plug into the control box.
- Place the sensor into the sensor line and secure the end cap. **DO NOT GLUE.**

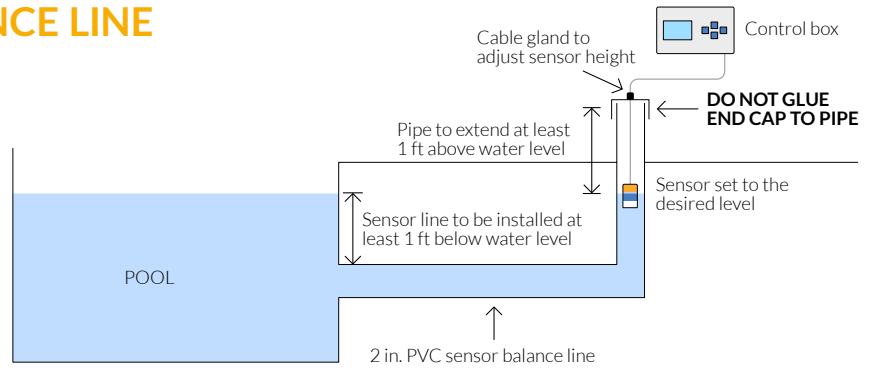

SET SENSOR LEVEL

- Fill the pool or water body to the required water level.
- Turn on power to the control box and water supply to the solenoid.
- Press **MODE** until you reach the **SET LEVEL** function.
- Loosen the cable gland on the top of the sensor end cap.
- Adjust the sensor height by feeding or pulling the cable through the gland.
- Slowly lower the sensor until **FILL** changes to **SCAN**.
- Tighten the cable gland to secure the sensor at the desired level.
- Press **ENTER** to confirm.

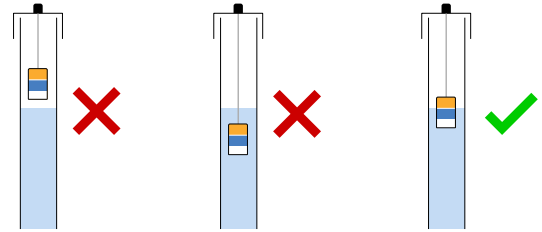
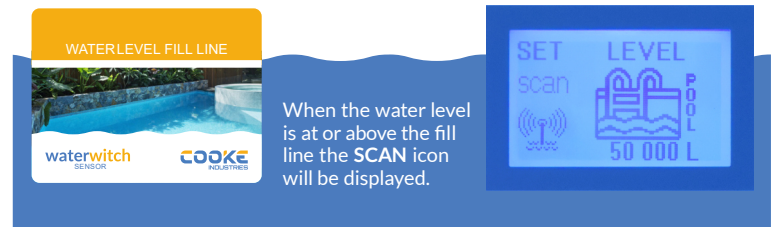
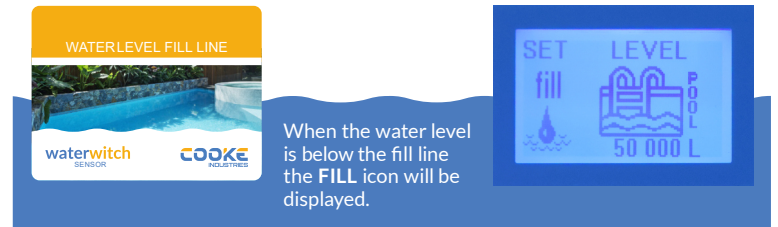

NOTE

If you have removed the plug at any point during installation, ensure the wires are reconnected as per the diagram (see right).

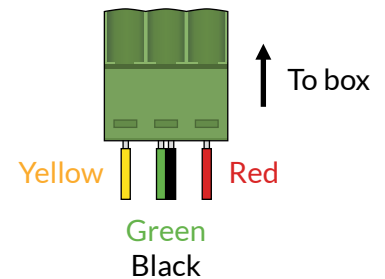

SET OPERATING MODE

- Press **MODE** until you reach the **SET TANK TYPE** function.
- Press **↑** or **↓** to scroll to correct tank type that the sensor is monitoring.
- Press **ENTER** to confirm tank type.
- Press **↑** or **↓** to adjust water volume.
- Press **ENTER** to confirm volume.

waterwitch

Your Water Witch is now set to operate reliably and effectively for many years.

Visit poolwaterwitch.com for a complete product guide, including a summary of available features, detailed installation and operational settings, and troubleshooting help.

